

Wiring scheme for D-CO LED

INPUT

86455937
 LED 0025 K210 24V One4all
 25W driver for wall asymmetric, dimmable

Switch Dimming

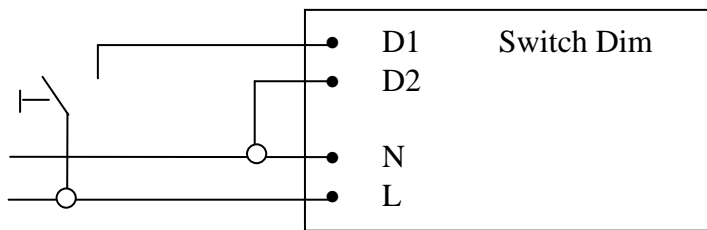

96107648
 LED CONVERTER 6W 350mA 230V DIMM
 6W driver for all downlights and spots, dimmable

1 to 10 Volt Dimming

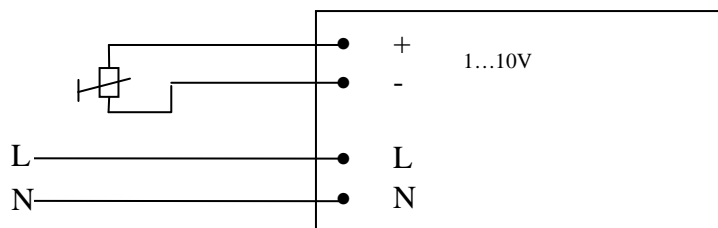

Push Dimming

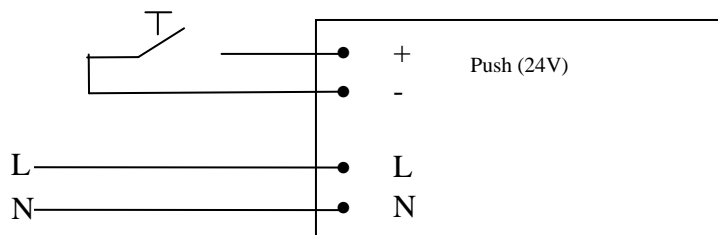

Wiring scheme for D-CO LED

INPUT

96107649
LED CONVERTER 15W 350mA 230V DIMM
15W driver for all downlights and spots, dimmable

1 to 10 Volt Dimming

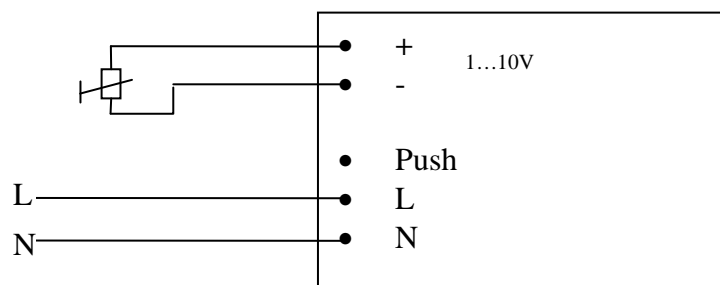

Push Dimming

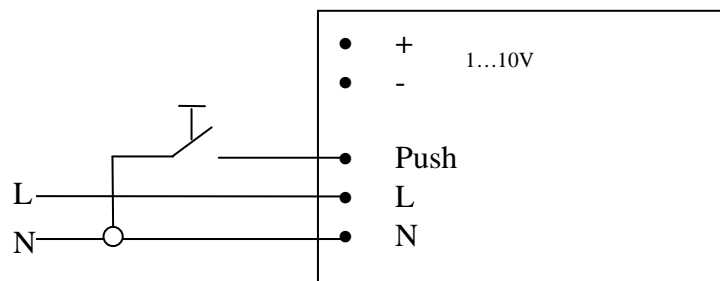

Wiring scheme for D-CO LED

THORN

OUTPUT for 350 mA
(all Downlights and Spot)

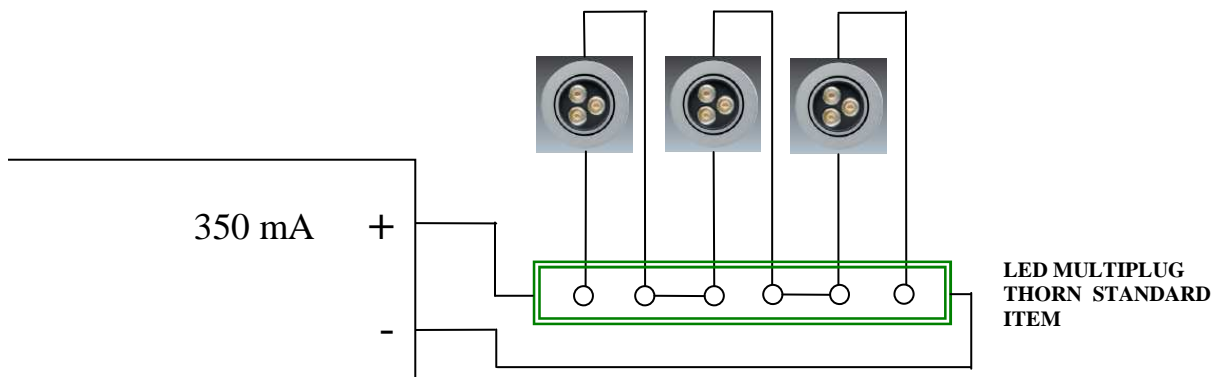
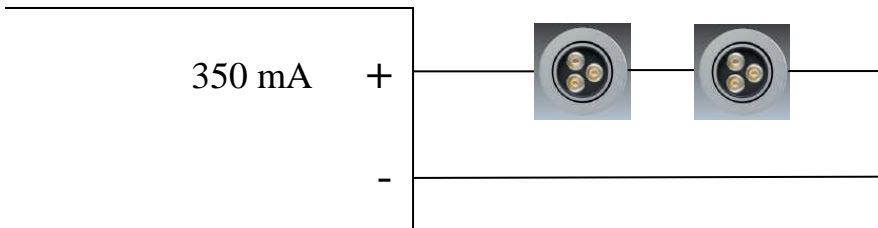
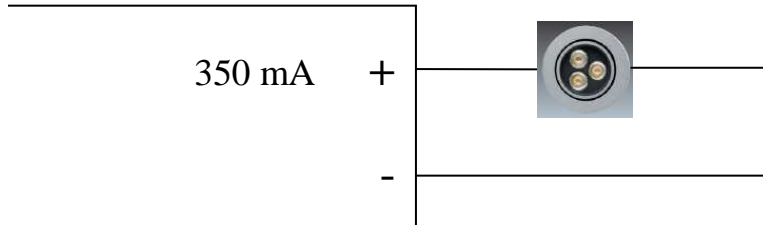

Wiring scheme for D-CO LED

THORN

OUTPUT for 24V
(Asymmetric Wall Recessed)

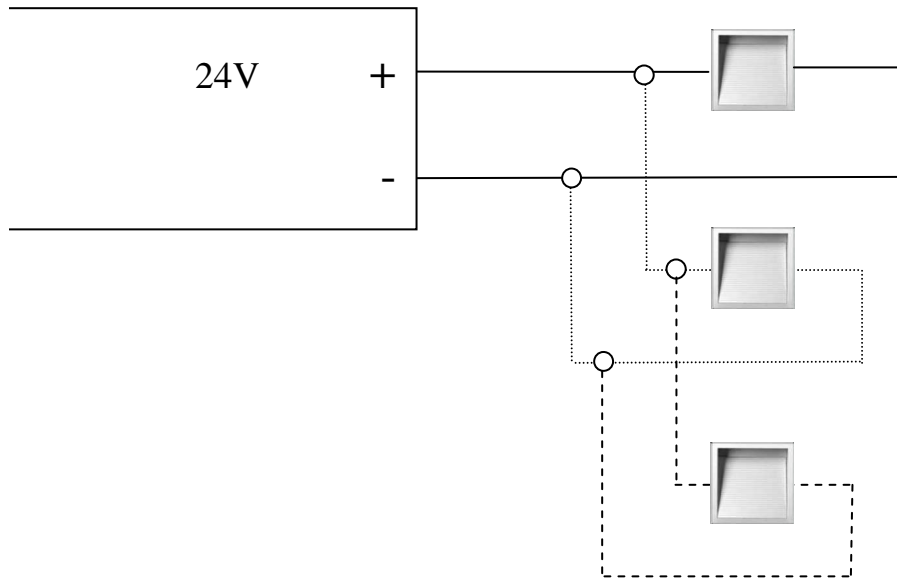

**ON SITE INSTALLATION BOX
STANDARD WHOLESALE ITEM**

