

96665751 CQ XL 144L35-740 NR BPS CLO CL1 PN M76



CiviTEQ

A Extra large size LED road lighting lantern with 144 LEDs driven at 350mA with Narrow Road optic. Electronic, fixed output control gear. Class I electrical, IP66, IK08. Housing: die-cast aluminium, Light grey 150 sanded textured (close to RAL9006). Enclosure: toughened flat glass. Screws: stainless steel, Ecolubric® treated. Supplied with Ø76mm spigot adaptor which can be fitted for post-top (0°/5°/10° tilt) or side-entry (-20°/-15°/-10°/-5°/0° tilt). Equipped with Nema photocell socket. Complete with 4000K LED. Surge protection: 10kV single pulse common mode and 8kV multipulse common mode and 6kV multipulse differential mode. If permanent DALI system is connected, 6kV multipulse common and differential mode.

Dimensions: 761 x 490 x 139 mm
 Luminaire input power: 149 W
 Luminaire luminous flux: 25058 lm
 Luminaire efficacy: 168 lm/W
 Weight: 20.1 kg
 Scx: 0.063 m²



TLG_CTEQ_F_XL.jpg

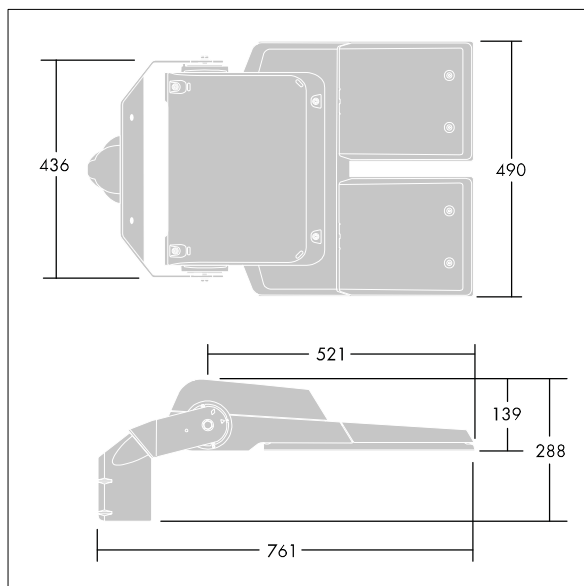

TLG_CETQ_M_CQ XL.wmf

This product contains light sources of energy efficiency class E.

All values marked with an * are rated values. Thorn uses tried and tested components from leading suppliers, however there may be isolated instances of technology-related failures of individual LEDs during the rated product lifetime. International standards set the tolerance in initial flux and connected load at ±10%. Unless stated otherwise, the values apply to an ambient temperature of 25°C.