

# Katona

# THORN

96631304 KAT RD 1400-830 HF

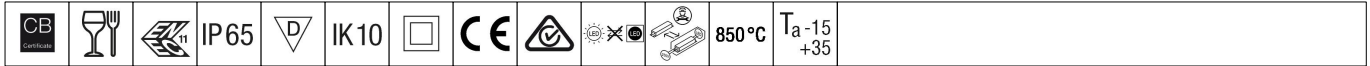

## Katona

A very slim, round functional LED luminaire. Fixed output LED driver. Body: polycarbonate. Diffuser: opal polycarbonate. Class II electrical, IP65, IK10. Complete with 3000K LED. Suitable for direct mounting to wall or ceiling. Loop-in, loop-out is possible for cables up to 2.5mm<sup>2</sup>. BESA compatible.

Dimensions: Ø307 x 58 mm  
Luminaire input power: 11.7 W  
Luminaire luminous flux: 1325 lm  
Luminaire efficacy: 113 lm/W  
Weight: 0.94 kg



TLG\_KATO\_F\_RD\_PDB.jpg

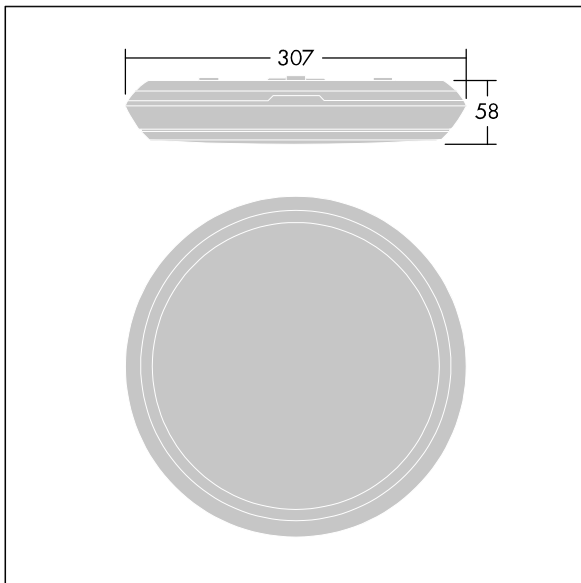

TLG\_KATO\_M\_RD\_LDS.wmf

This product contains a light source of energy efficiency class D.

All values marked with an \* are rated values. Thorn uses tried and tested components from leading suppliers, however there may be isolated instances of technology-related failures of individual LEDs during the rated product lifetime. International standards set the tolerance in initial flux and connected load at ±10%. Unless stated otherwise, the values apply to an ambient temperature of 25°C.

Thorn Lighting is constantly developing and improving its products. The right is reserved to change specifications without prior notification or public announcement.  
© Thorn Lighting

**Katona**

**96631304 KAT RD 1400-830 HF**

**THORN**