

Flow

THORN

92934238 FW 36L50 730 NR BS 3550 CL2 T60F ANT

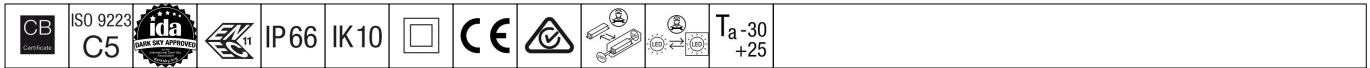

Flow

A highly versatile LED lantern with a Narrow Road, asymmetric distribution. Electronic, DALI dimmable control gear driving 36 LEDs at 500mA. Compatible with PL, LRT, 7 pin Nema socket. Class II electrical, IP66, IK10. Housing, canopy and spigot: die-cast aluminium (EN AC-47100) powder coated anthracite (close to RAL7043).. Enclosure: 6mm thick clear glass. BSxyz: Autonomous, physically disconnectable, bi-power reduction (x: hours before midnight, y: hours after midnight, zz: reduction (%)). Complete with 3000K LED. Post top mounting to Ø60mm column, tilt 5°, adjustable from 0° to +10°.

Surge protection: 10kV single pulse common mode and 8kV multipulse common mode and 6kV multipulse differential mode. If permanent DALI system is connected, 6kV multipulse common and differential mode.

Dimensions: 435 x 436 x 200 mm
Luminaire input power: 55 W
Luminaire luminous flux: 7598 lm
Luminaire efficacy: 138 lm/W
Weight: 8.5 kg
Scx: 0.054 m²



TLG_FLOW_F_MTP_CL.jpg

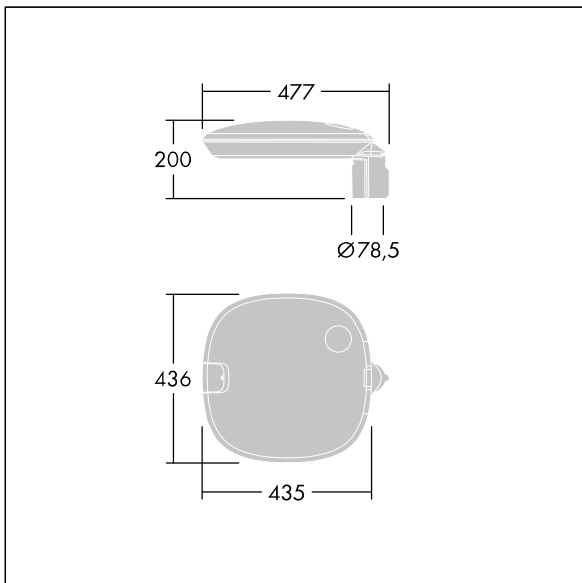

TLG_FLOW_M_MTP60.wmf

This product contains a light source of energy efficiency class D.

All values marked with an * are rated values. Thorn uses tried and tested components from leading suppliers, however there may be isolated instances of technology-related failures of individual LEDs during the rated product lifetime. International standards set the tolerance in initial flux and connected load at ±10%. Unless stated otherwise, the values apply to an ambient temperature of 25°C.

Thorn Lighting is constantly developing and improving its products. The right is reserved to change specifications without prior notification or public announcement.
© Thorn Lighting