

Contus

96635828 CONTUS T L2000 WH

THORN



Contus

Roll-formed sheet steel trunking units powder coated with white polyester lacquer. 5 mains power lines (5 x 2.5mm²/16A) plus 2 x 2 conductors (4 x 1.5mm²/10A) for integrating emergency lighting using two independently isolated circuits, plus and 2 control-line conductors (2 x 1.5mm²/10A). Tool-free connection using electrical feed kit.

Dimensions: 2018 x 60 x 58 mm
Weight: 3.7 kg

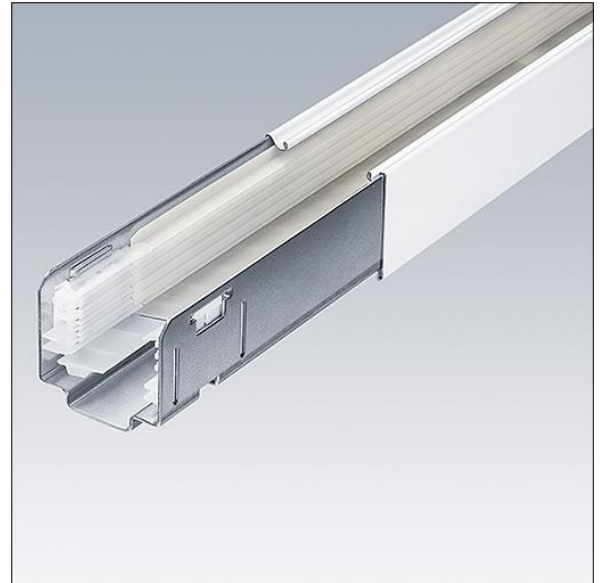

TLG_CONT_F_TRUNKING2.jpg

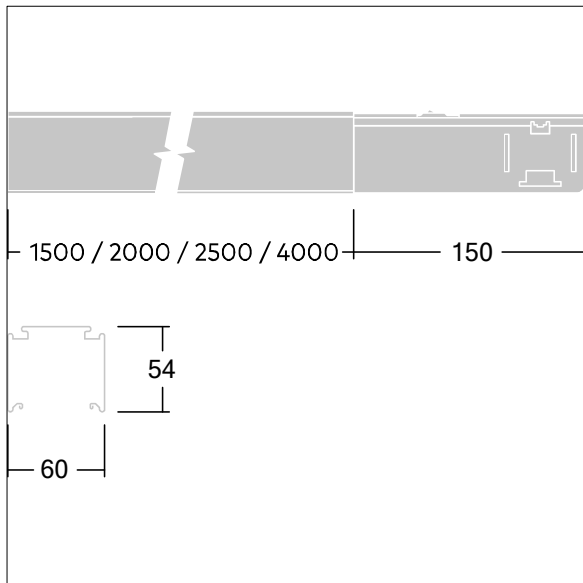

TL_CONTUS_M_Trunking.wmf

All values marked with an * are rated values. Unless stated otherwise, the values apply to an ambient temperature of 25°C.

Thorn Lighting is constantly developing and improving its products. The right is reserved to change specifications without prior notification or public announcement.
© Thorn Lighting