

Avenue Wall 300 II

THORN

96258554 AVENUE W300 II LED 12L35 730 CL2



Avenue Wall 300 II

Avenue Deco wall light. Class II electrical, IP65, with opal polycarbonate bowl. Complete with integral control gear and 14W LED source. Complete with 3000K LED

Dimensions: 313 x 176 x 362 mm

Luminaire input power: 15 W

Weight: 3.42 kg



TLG_AVNE_F_W300PDBUNLIT.jpg

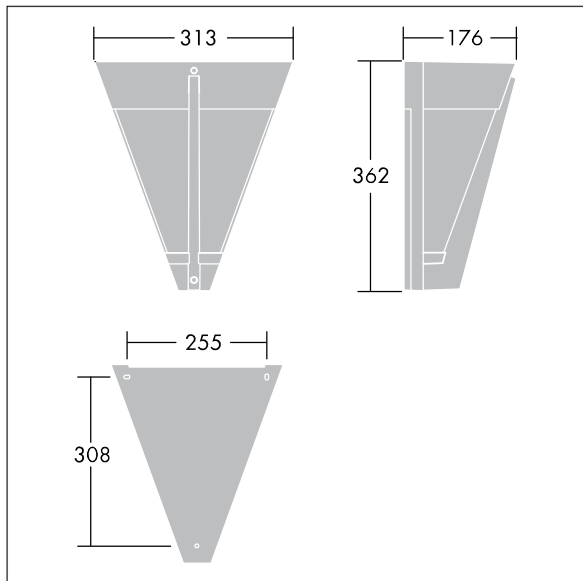

TLG_AVED_M_LDW300.wmf

This product contains a light source of energy efficiency class D.

All values marked with an * are rated values. Thorn uses tried and tested components from leading suppliers, however there may be isolated instances of technology-related failures of individual LEDs during the rated product lifetime. International standards set the tolerance in initial flux and connected load at $\pm 10\%$. Unless stated otherwise, the values apply to an ambient temperature of 25°C.

Thorn Lighting is constantly developing and improving its products. The right is reserved to change specifications without prior notification or public announcement.
© Thorn Lighting

Avenue Wall 300 II

96258554 AVENUE W300 II LED 12L35 730 CL2

THORN