

Dyana

THORN

96261027 DYA 12L70-740 NR BP 3550 CL1 L60E ANT



Dyana

A high quality LED luminaire with narrow light distribution and Electronic, Programmable control gear. Equipped with 50% power reduction circuit, effective 3 hours before and 5 hours after a calculated midnight. Body, canopy and spigot: die-cast aluminium, textured anthracite finish. Enclosure: 5mm thick, toughened glass. Class I electrical, IP66. Supplied, ready to install, in a single box. Complete with 4000K LED

Mounting: Ø60mm side entry with 0° tilt. Adjustable to -5° tilt or post-top with 5° or 10° tilt.

Dimensions: 685 x 511 x 92 mm
Luminaire input power: 27 W
Weight: 10.84 kg
Scx: 0.03 m²



TLG_DYNA_F_1MLEDPDB_1_14.jpg

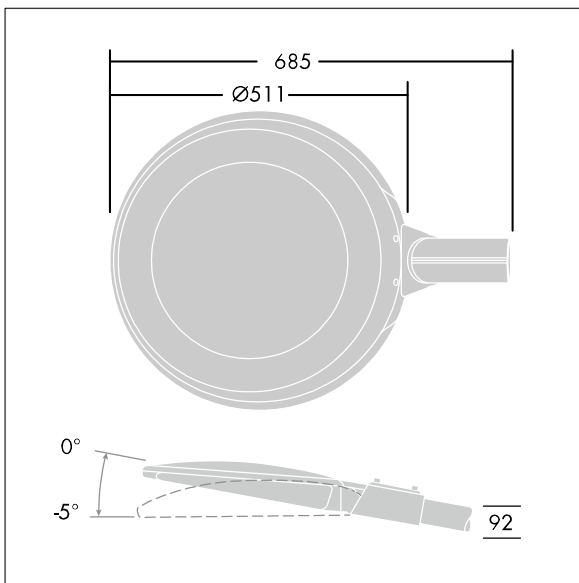

TLG_DYNA_M_LED MLE.wmf

This product contains a light source of energy efficiency class D.

All values marked with an * are rated values. Thorn uses tried and tested components from leading suppliers, however there may be isolated instances of technology-related failures of individual LEDs during the rated product lifetime. International standards set the tolerance in initial flux and connected load at ±10%. Unless stated otherwise, the values apply to an ambient temperature of 25°C.

Thorn Lighting is constantly developing and improving its products. The right is reserved to change specifications without prior notification or public announcement.
© Thorn Lighting