

Avenue F2

THORN

96270652 AVF 18L50 740 RS FR BS 3550 CL2 N4M ->



Avenue F2

Decorative post-top lantern with symmetric distribution. Class II electrical, IP66, IK08. Base and arms: die-cast aluminium (EN AC-46000), Canopy: spun aluminium, all powder coated dark sandy grey 900 (close to RAL7043). Diffuser: frosted polycarbonate. Screw fixings: stainless steel. Supplied complete in one box, pre-wired with 4m HO5 VVF cable. Surge protection: 10kV single pulse common mode and 8kV multipulse common mode and 6kV multipulse differential mode. If permanent DALI system is connected, 6kV multipulse common and differential mode. Complete with 4000K LED

Post top mounted on a spigot of Ø60mm, length 100mm.

Dimensions: Ø700/720 x 500 mm
Luminaire input power: 31 W
Weight: 9.4 kg
Scx: 0.17 m²



TLG_AVNF_F_3_AR2_1700.jpg

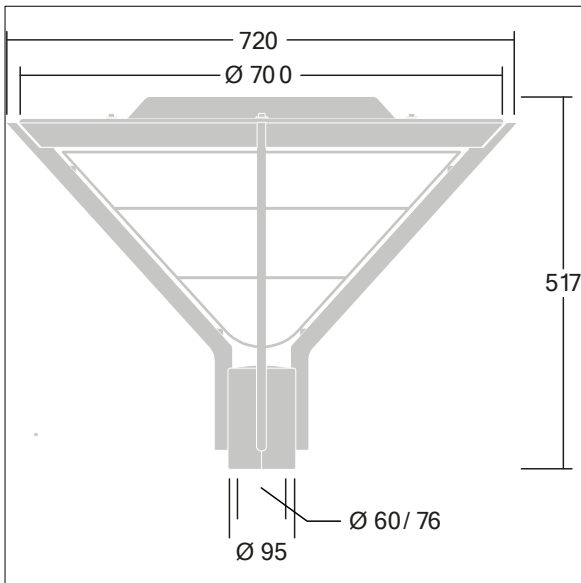

TLG_AVNF_M_LD1.wmf

All values marked with an * are rated values. Thorn uses tried and tested components from leading suppliers, however there may be isolated instances of technology-related failures of individual LEDs during the rated product lifetime. International standards set the tolerance in initial flux and connected load at ±10%. Unless stated otherwise, the values apply to an ambient temperature of 25°C.

Thorn Lighting is constantly developing and improving its products. The right is reserved to change specifications without prior notification or public announcement. © Thorn Lighting

Avenue F2

96270652 AVF 18L50 740 RS FR BS 3550 CL2 N4M ->

THORN