

# Thor

# THORN

96643919 TR 48L50-740 SC BP CL1 OP W9 L60E

ISO 9223 C5	IP66	IK08							T <sub>a</sub> 0 +25
----------------	------	------	--	--	--	--	--	--	-------------------------

## Thor

A large size, smart urban LED lantern with 48 LEDs driven at 500mA with Street & Comfort optic and UV stabilised polycarbonate dome with opal finish. Class I electrical, IP66, IK08. Body, bracket and ring: die-cast aluminium (AS12U, LM6 equivalent, EN AC-44300) treated against corrosion, powder coated anthracite (close to RAL7043). Enclosure: 4mm toughened flat glass. Screws and closing set: stainless steel. Pre-wired with 9m cable. Side entry mounting to Ø60mm spigot, tilt 0°, adjustable from -15° to +10°. Equipped with power reduction circuit, effective 3 hours before and 5 hours after a calculated midnight. Complete with 4000K LED.

Dimensions: Ø577 x 155 mm  
Luminaire input power: 79 W  
Luminaire luminous flux: 10644 lm  
Luminaire efficacy: 135 lm/W  
Weight: 14.2 kg  
Scx: 0.044 m<sup>2</sup>



TLG\_THRL\_F\_MLEOP0.jpg

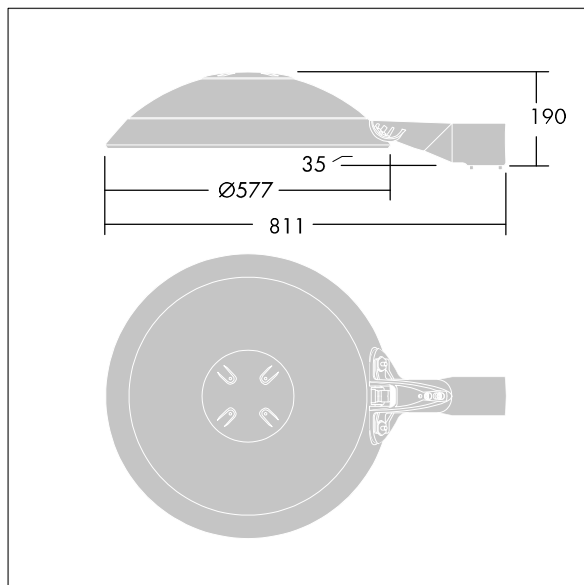

TLG\_THOR\_M\_BRK.wmf

This product contains light sources of energy efficiency class D.

All values marked with an \* are rated values. Thorn uses tried and tested components from leading suppliers, however there may be isolated instances of technology-related failures of individual LEDs during the rated product lifetime. International standards set the tolerance in initial flux and connected load at ±10%. Unless stated otherwise, the values apply to an ambient temperature of 25°C.

Thorn Lighting is constantly developing and improving its products. The right is reserved to change specifications without prior notification or public announcement.  
© Thorn Lighting