

## Areaflood Pro

96644851 AFP S 36L70-740 EWR HFX CL2 GY

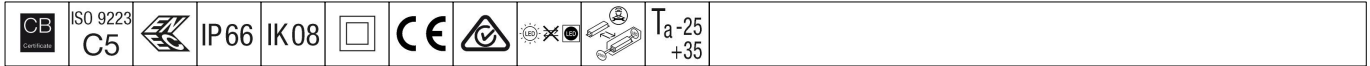

### Areaflood Pro

A compact, lightweight, general purpose LED area floodlight. With small body, LED converter configured for DALI control over additional wires, driving 36 LEDs at 700mA with Extra Wide Road light distribution. IP66, IK08, Class II electrical. Body: die-cast aluminium (EN AC-44300), Light grey 150 sanded textured (close to RAL9006).. Enclosure: 4mm thick toughened glass. Reversible mounting stirrup supplied, Complete with 4000K LED.

Dimensions: 462 x 265 x 139 mm  
 Luminaire input power: 77 W  
 Luminaire luminous flux: 11488 lm  
 Luminaire efficacy: 149 lm/W  
 weight: 6.29 kg  
 Scx: 0.05 m<sup>2</sup>



TLG\_AFLP\_F\_SMALLPDB.jpg

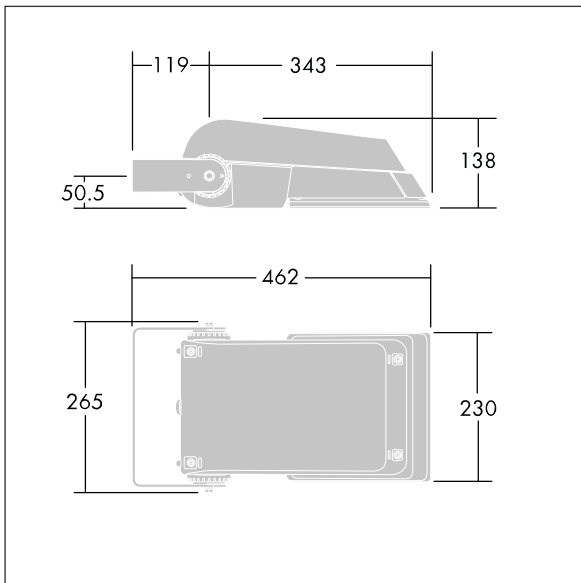

TLG\_AFLP\_M\_SML.wmf

This product contains light sources of energy efficiency class E.

# Areaflood Pro

96644851 AFP S 36L70-740 EWR HFX CL2 GY

THORN