

# Thor

# THORN

96665359 TR 36L50 740 SC LRT CL2 FD MSU34GM ANT



## Thor

A small size, smart urban LED lantern with 36 LEDs driven at 500mA with Street & Comfort optic and die-cast aluminium EN AC 47100 + CAT dome with anthracite finish (close to RAL7043). Class II electrical, IP66, IK10. Body: die-cast aluminium (EN AC 46100) treated against corrosion, powder coated anthracite (close to RAL7043). Enclosure: 6mm toughened flat glass. Screws and closing set: stainless steel. Suspended through 34G. Equipped with power reduction circuit, controlled by an additional switched phase cable. ON = 100%, OFF = 50%. Complete with 4000K LED.

Dimensions: Ø459 x 268 mm  
Luminaire input power: 55 W  
Luminaire luminous flux: 8520 lm  
Luminaire efficacy: 155 lm/W  
Weight: 8.2 kg  
Scx: 0.035 m<sup>2</sup>



TLG\_THOR\_F\_SMSU.jpg

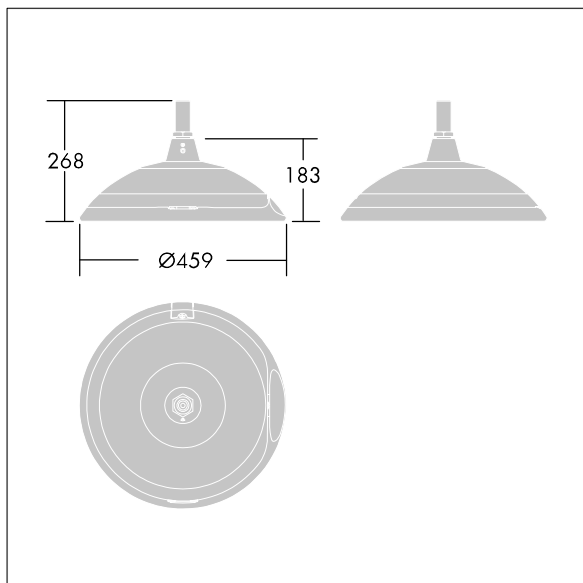

TLG\_THOR\_M\_MSU 34G 1.wmf

This product contains a light source of energy efficiency class E.

All values marked with an \* are rated values. Thorn uses tried and tested components from leading suppliers, however there may be isolated instances of technology-related failures of individual LEDs during the rated product lifetime. International standards set the tolerance in initial flux and connected load at ±10%. Unless stated otherwise, the values apply to an ambient temperature of 25°C.

Thorn Lighting is constantly developing and improving its products. The right is reserved to change specifications without prior notification or public announcement.  
© Thorn Lighting