

Novaline Style

96635533 NOVS S 1400-840 DI HFI BK

THORN

IEC EN 60598-1 RG 1	RoHS	UK CA	11	IP54	D	halogen	IK08		CE					850°C	T _a -15 +25	
---------------------------	------	----------	----	------	---	---------	------	--	----	--	--	--	--	-------	---------------------------	--

Novaline Style

Decorative circular luminaire with small body. Low indirect component for wall and ceiling illumination. Electronic, DALI dimmable. Aesthetic trim of the luminaire made of polycarbonate in black. Diffuser: opal polycarbonate. Class II electrical, IP54. Complete with 4000K LED.

Dimensions: Ø320 x 69 mm
Luminaire input power: 9.7 W
Luminaire luminous flux: 1400 lm
Luminaire efficacy: 144 lm/W
Weight: 1.68 kg



TLG_NOVS_F_3BK.jpg

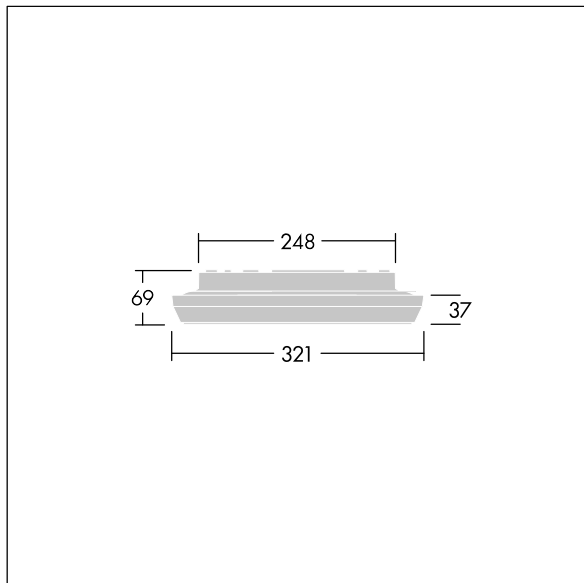

TLG_NOVS_M_LD300.wmf

This product contains a light source of energy efficiency class C.

All values marked with an * are rated values. Thorn uses tried and tested components from leading suppliers, however there may be isolated instances of technology-related failures of individual LEDs during the rated product lifetime. International standards set the tolerance in initial flux and connected load at $\pm 10\%$. Unless stated otherwise, the values apply to an ambient temperature of 25°C.

Thorn Lighting is constantly developing and improving its products. The right is reserved to change specifications without prior notification or public announcement.
© Thorn Lighting