

Altis Gen5

THORN

96671924 ALG5 GB 2052W 1.40A 565V 3CH DA

IP66 IK08     Ta45

Altis Gen5

Class I, DALI 2 programmable gearbox, with 3 independent output channels and IP66 enclosure, for TV broadcasting applications. Suitable for dedicated 432 / 456 / 480 / 504 LED Altis floodlight, to be installed remotely up to 200m from the floodlight. Nominal input voltage: 200-440, output current 1400mA with DALI 2 configurable single-channel, IEEE 1789 flicker recommended practice compliant suitable for super slow motion camera filming, surge level 10kV for both common mode and differential.

Connection from mains via terminal blocks. Mains supply must be fused according to local safety regulations.

Weight: 6.2 kg.



TLG_ALT5_F_GB_1700.jpg

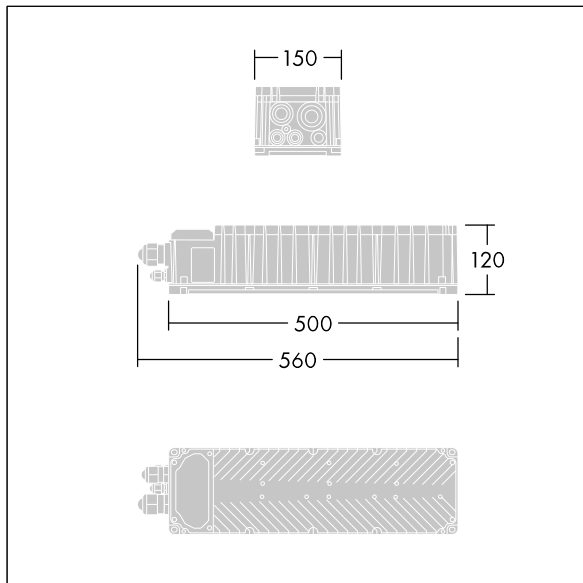

TLG_ALT5_M_GB.wmf

All values marked with an * are rated values. Unless stated otherwise, the values apply to an ambient temperature of 25°C.

Thorn Lighting is constantly developing and improving its products. The right is reserved to change specifications without prior notification or public announcement.
© Thorn Lighting