

# Isaro Pro

96636172 IP 24L105-740 NR BP 3550 CL2 M60 GY-S

# THORN

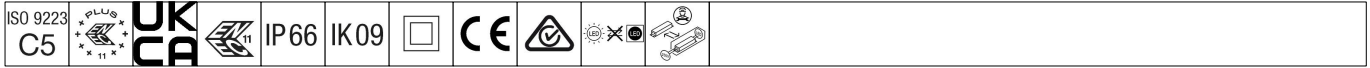

## Isaro Pro

A state of the art LED road lighting lantern (small) with 24 LEDs driven at 1050mA with Narrow Road optic. Programmable LED driver. Class II electrical, IP66, IK09. Housing: die-cast aluminium (EN AC-44300), powder coated textured light grey 150 (close to RAL9006). Spigot: die-cast aluminium (EN AC-44300), unpainted. Enclosure: 5mm thick glass. Fixings: spring steel. Supplied with Ø60mm spigot adaptor which can be fitted for post-top (0°/5°/10°/15°/20° tilt) or side-entry (-15°/-10°/-5°/0°/5°/10°/15° tilt). Equipped with 50% power reduction circuit, effective 3 hours before and 5 hours after a calculated midnight. Complete with 4000K LED. Surge protection: 10kV single pulse common mode and 8kV multipulse common mode and 6kV multipulse differential mode. If permanent DALI system is connected, 6kV multipulse common and differential mode.

Dimensions: 571 x 224 x 114 mm  
Luminaire input power: 78.5 W  
Luminaire luminous flux: 10936 lm  
Luminaire efficacy: 139 lm/W  
Weight: 5.33 kg  
Scx: 0.054 m<sup>2</sup>



TLG\_ISRP\_F\_PDB\_SIL.jpg

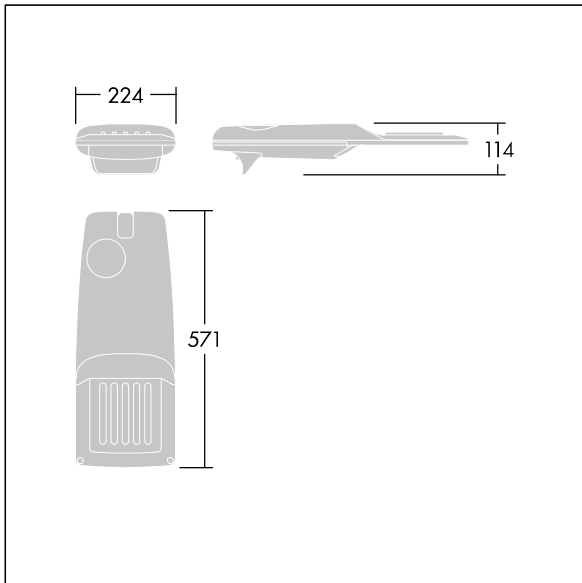

TLG\_ISRP\_M\_LD1.wmf

This product contains a light source of energy efficiency class D.

All values marked with an \* are rated values. Thorn uses tried and tested components from leading suppliers, however there may be isolated instances of technology-related failures of individual LEDs during the rated product lifetime. International standards set the tolerance in initial flux and connected load at ±10%. Unless stated otherwise, the values apply to an ambient temperature of 25°C.

Thorn Lighting is constantly developing and improving its products. The right is reserved to change specifications without prior notification or public announcement.  
© Thorn Lighting

**Isaro Pro**

**96636172 IP 24L105-740 NR BP 3550 CL2 M60 GY-S**

**THORN**