



### CiviTEQ

A small size LED road lighting lantern with 24 LEDs driven at 350mA with Narrow Road optic. Electronic, fixed output control gear. Class II electrical, IP66, IK08. Housing: die-cast aluminium (EN AC-44300), Light grey 150 sanded textured (close to RAL9006). Enclosure: toughened flat glass. Screws: stainless steel, Ecolubric® treated. Supplied with Ø60mm spigot adaptor which can be fitted for post-top (0°/5°/10° tilt) or side-entry (-20°/-15°/-10°/-5°/0° tilt). BPxyz: Autonomous bi-power reduction (x: hours before midnight, y: hours after midnight, zz: reduction (%)) Complete with 4000K LED. Surge protection: 10kV single pulse common mode and 8kV multipulse common mode and 6kV multipulse differential mode. If permanent DALI system is connected, 6kV multipulse common and differential mode.

Dimensions: 390 x 230 x 133 mm  
 Luminaire input power: 25.7 W  
 Luminaire luminous flux: 4334 lm  
 Luminaire efficacy: 169 lm/W  
 Weight: 5.74 kg  
 Scx: 0.077 m<sup>2</sup>



TLG\_CTEQ\_F\_SMTp36LEDPDB.jpg

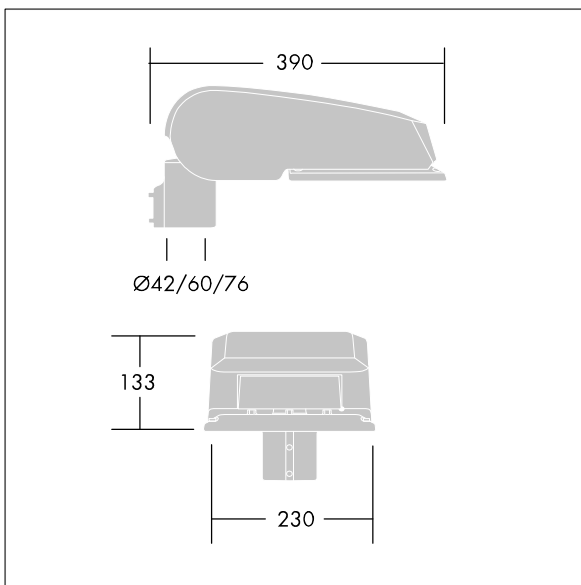

TLG\_CETQ\_M\_S.wmf

This product contains light sources of energy efficiency class D.

All values marked with an \* are rated values. Thorn uses tried and tested components from leading suppliers, however there may be isolated instances of technology-related failures of individual LEDs during the rated product lifetime. International standards set the tolerance in initial flux and connected load at ±10%. Unless stated otherwise, the values apply to an ambient temperature of 25°C.

Thorn Lighting is constantly developing and improving its products. The right is reserved to change specifications without prior notification or public announcement.  
 © Thorn Lighting