

## 96636340 IS XS 24L25-730 NR CL1 WS0.3 M60 GY-S



### Isaro

A discrete and flexible road and street lantern with durable high performance. Programmable LED driver, set for fixed output, driving 24 LEDs at 250mA. Body: extra small size, die-cast aluminium (EN AC-44300), powder coated textured Light grey textured (150) - partly painted. Shaft: Light grey textured (150) - partly painted/unpainted. Cover: Extra White glass. Fixings: stainless steel with anti-galvanic treatment. narrow road optic, with Colour Rendering Index min.: 70, Correlated colour temperature\*: 3000 Kelvin LEDs supplied. Class I electrical, Impact strength: IK08, IP66, Ta max.: °C. Supplied with Ø60mm spigot adaptor which can be fitted for post-top (0°/5°/10° tilt) or side-entry (-20°/-15°/-10°/-5°/0° tilt). Pre-wired with 0.3m, 1.5mm² H07RN-F cable.

Dimensions: 508 x 180 x 157 mm  
 Luminaire input power: 18.9 W  
 Luminaire luminous flux: 2824 lm  
 Luminaire efficacy: 149 lm/W  
 Weight: 3.3 kg  
 Scx: 0.028 m²



TLG\_ISLC\_F\_XS\_ZU\_SR.jpg

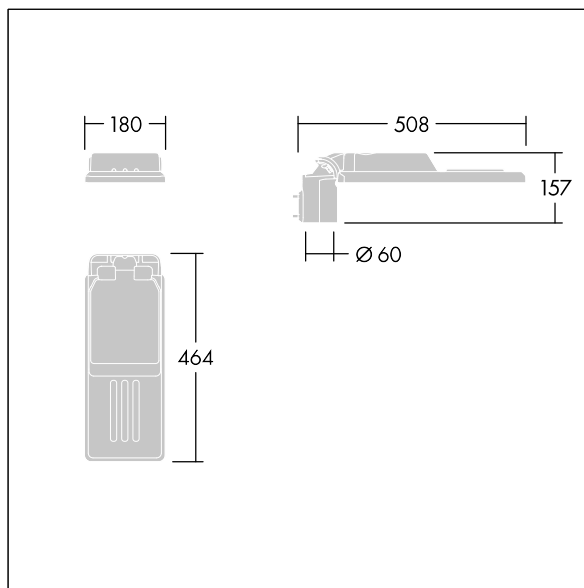

TLG\_ISLC\_M\_XSMTP60.wmf

This product contains a light source of energy efficiency class D.

All values marked with an \* are rated values. Thorn uses tried and tested components from leading suppliers, however there may be isolated instances of technology-related failures of individual LEDs during the rated product lifetime. International standards set the tolerance in initial flux and connected load at ±10%. Unless stated otherwise, the values apply to an ambient temperature of 25°C.

**Isaro**

**96636340 IS XS 24L25-730 NR CL1 WS0.3 M60 GY-S**

**THORN**